

주중한국문화원 1F / B1F

공사 예상 범위

2020. 12. 18.

지하 1층 벽체 및 커튼레일

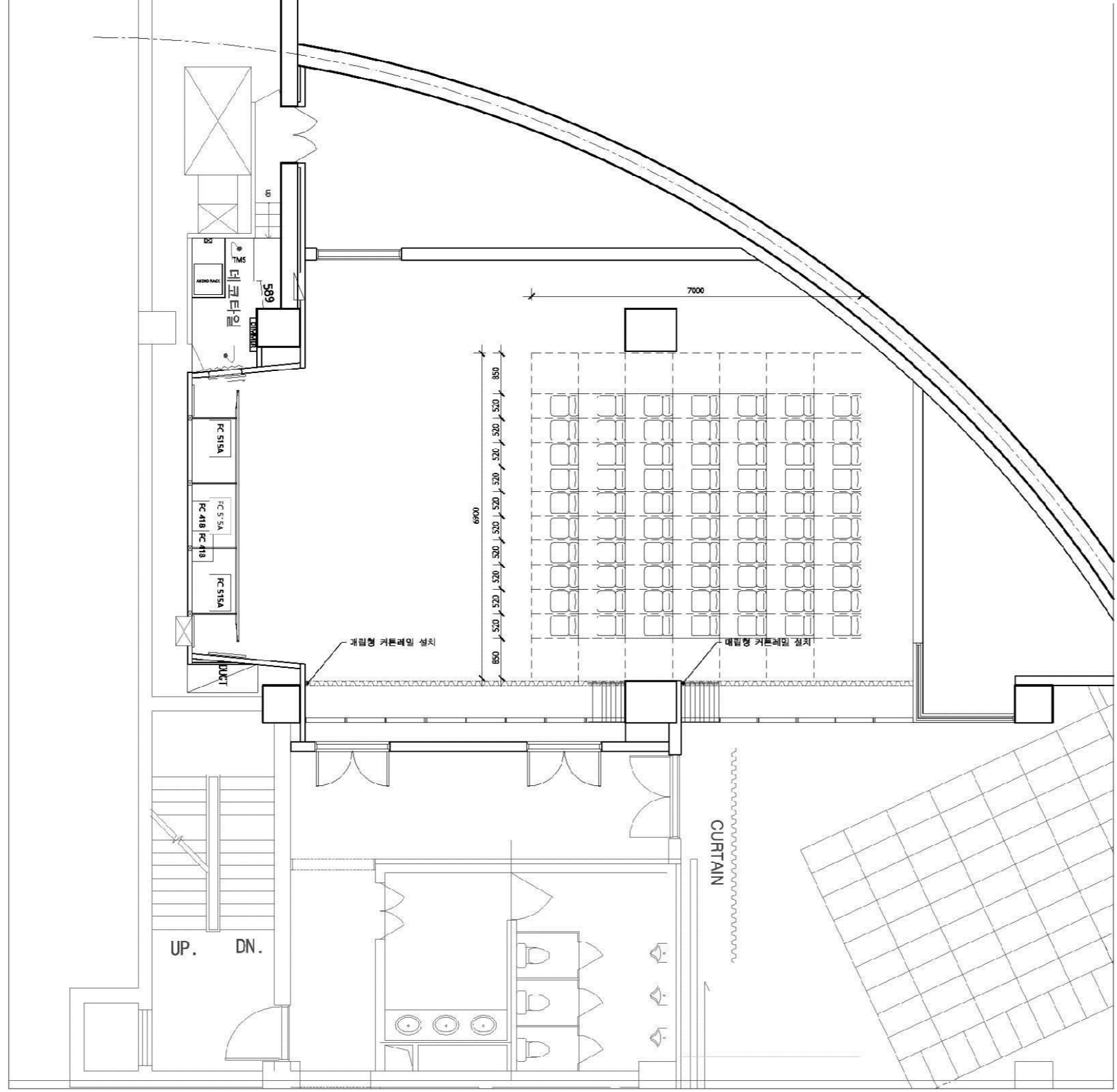

FLOOR PLAN

SCALE:1/100

TITRE DU PROJET 주중 한국문화원 지하1층	Site	Beijing, China	ARCHITECTE/ENTREPRENEUR	le sixième
	DATE DU PLAN	FLOOR PLAN	1639 - 14, Secho-dong, Secho - O., Seoul, Korea T. 82-2-1363-3030 F. 82-2-363-7027 www.sixieme.co.kr	
	Date	NOV/2016	N° de dessin	
	N° de projet		Échelle	
Ne pas modifier les mesures sur ce plan				

지하 1층 벽체 및 커튼레일

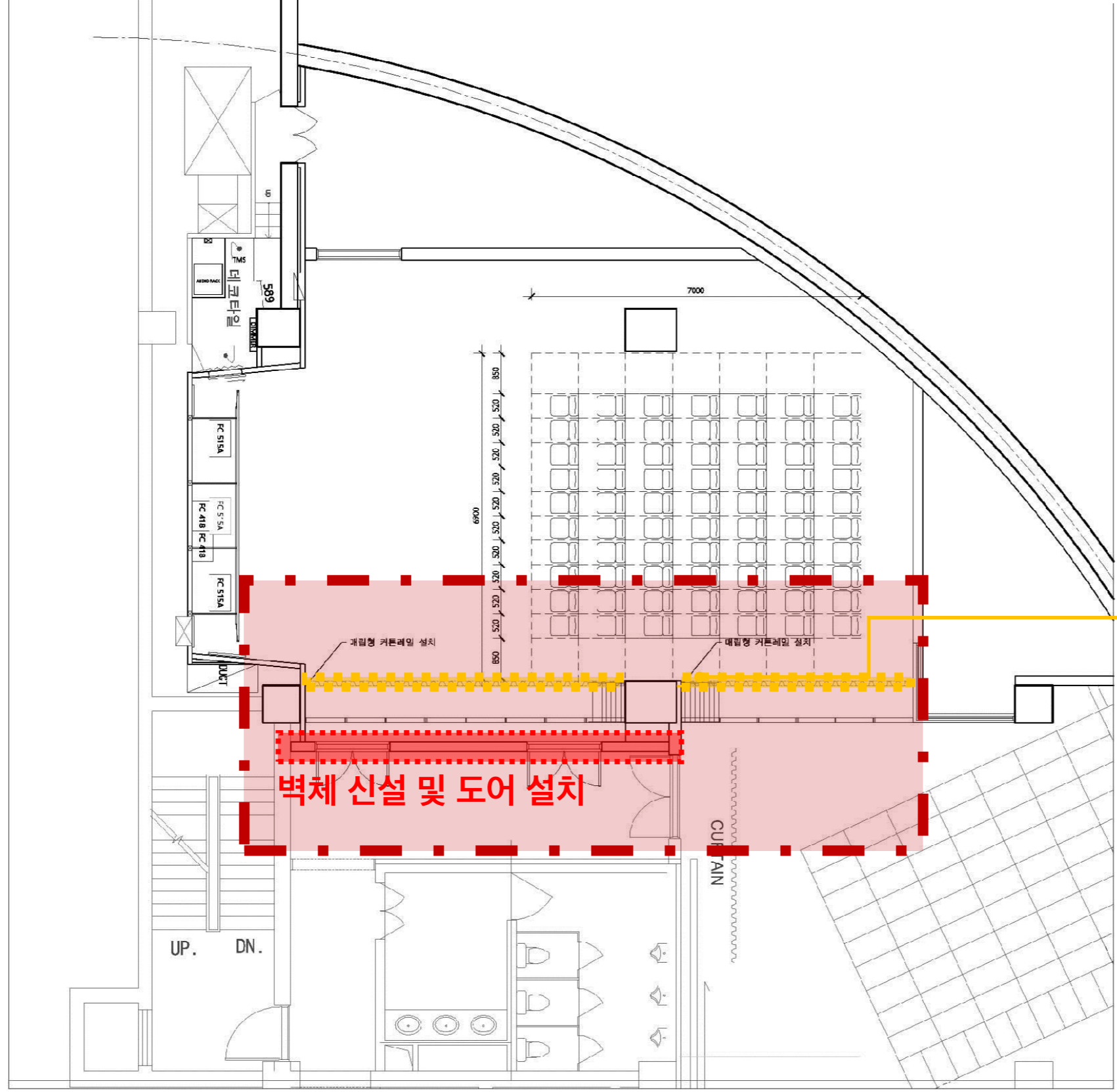

커튼레일 설치

벽체 신설 및 도어 설치



FLOOR PLAN
SCALE:1/100

TITRE DU PROJET 주중 한국문화원 지하1층	OBJET	Beijing, China	ARCHITECTE/ENTREPRENEUR	le sixième
	DATE DU PLAN	FLOOR PLAN	1639 - 14, Secho-dong, Secho - O., Seoul, Korea T. 82-2-363-7027 F. 82-2-363-7027 www.sixieme.co.kr	
	DATE	NOV 2016		
	N° de projet			
	N° de dessin			
	Ne pas modifier ou mesurer sur ce plan			

1층 전시장 신설

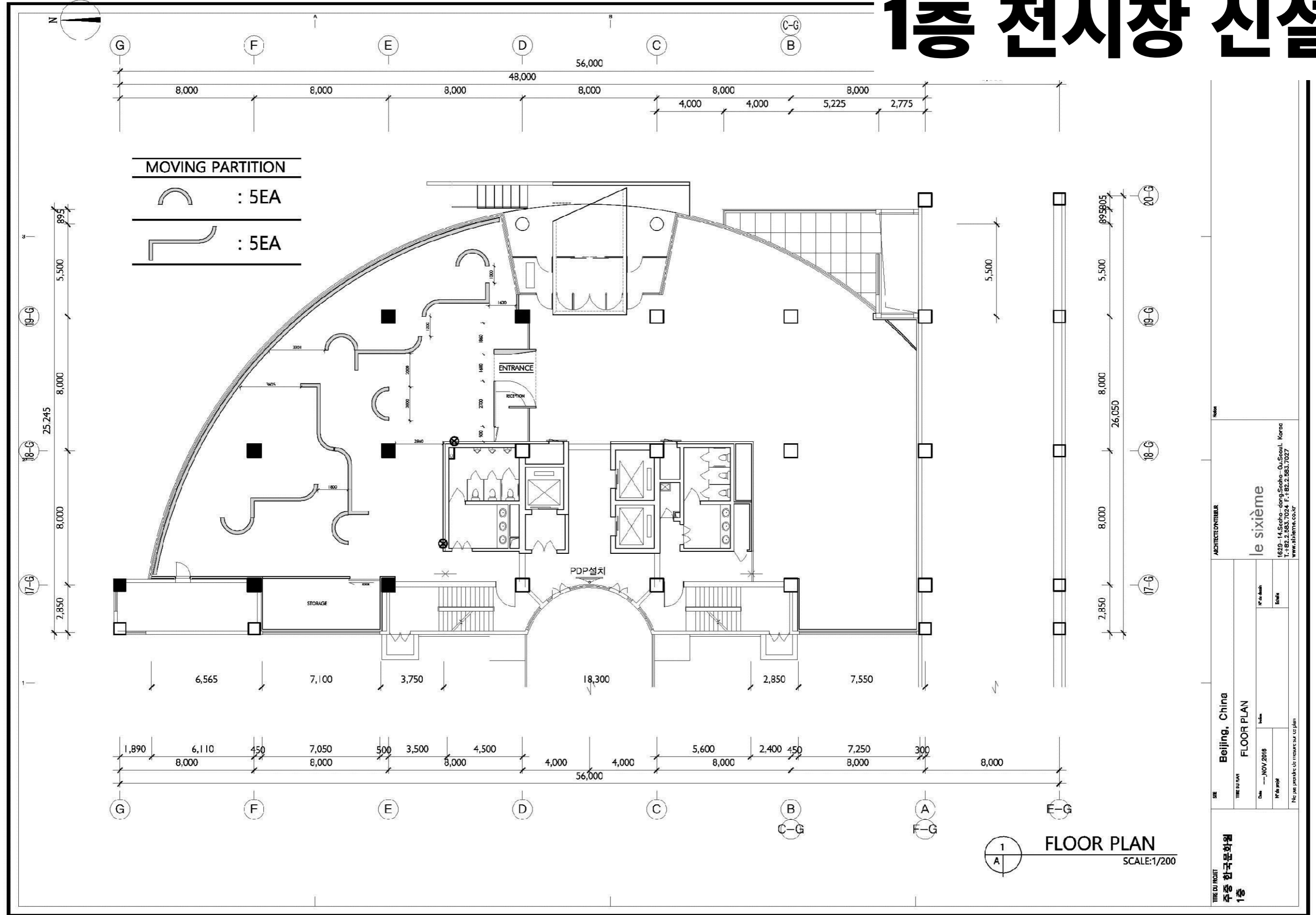

TITRE DU PROJET 주중 한국문화원 1층	SITE Beijing, China	ARCHITECTE/ENTREPRENEUR le sixième
	DATE NOV 2016	1639 - 14, Secho-dong, Secho-0, Seoul, Korea T: 82-2-363-7027 F: 82-2-363-7027 www.le6ieme.co.kr
FLOOR PLAN	No. de plan Date	No. de plan Date
No. de plan Date		

1층 전시장 신설

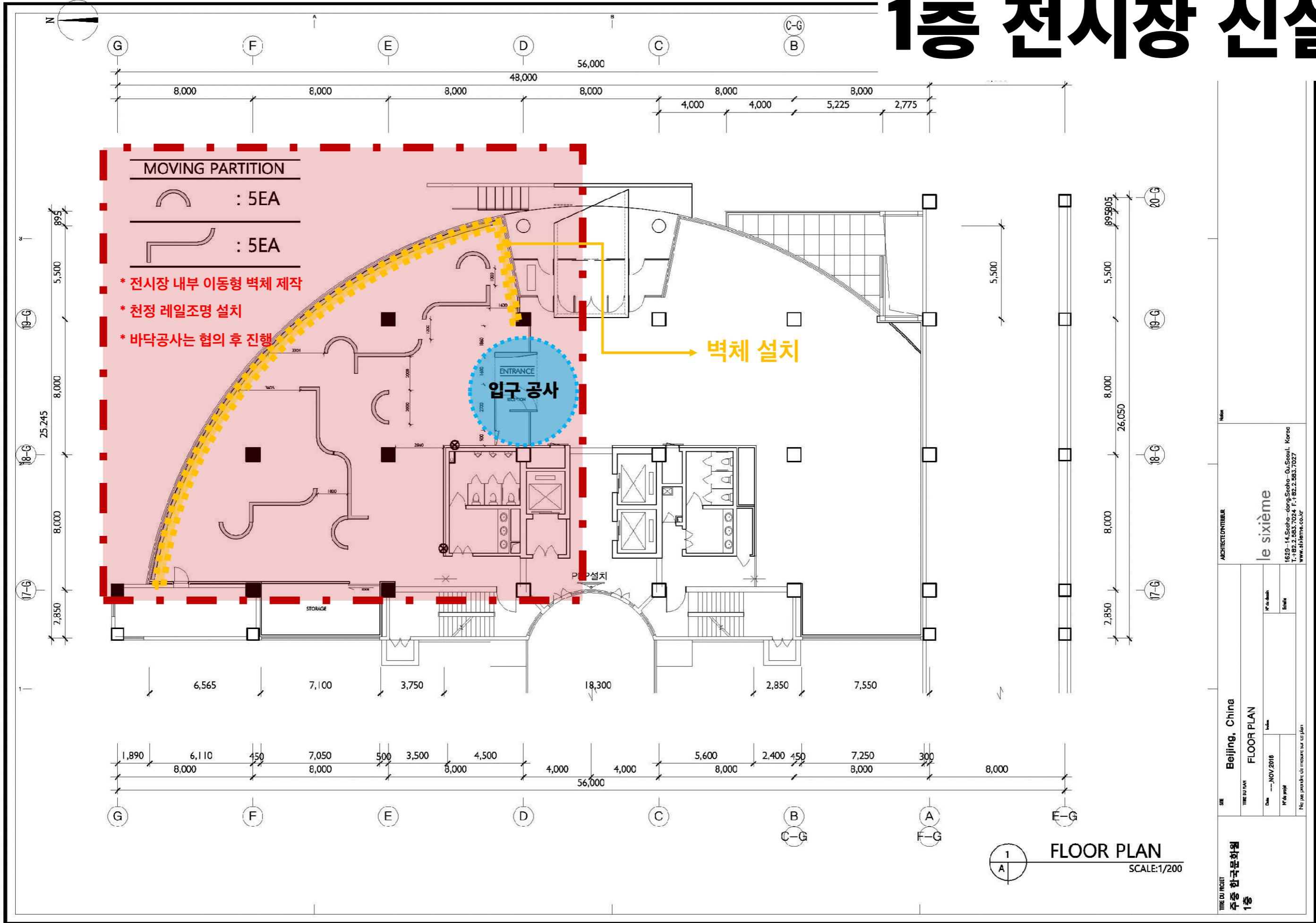

TITRE DU PROJET 주중 한국문화원 1층		SIE Beijing, China		ARCHITECTE/ENTREPRENEUR le sixième	
DATE DU PLAN NOV 2016		DATE NOV 2016		1639 - 14, Secho-dong, Secho-0, Seoul, Korea T: 82-2-363-7027 F: 82-2-363-7027 www.le6ieme.co.kr	
N° de plan		N° de dessin		Echelle	
Ne pas modifier ou mesurer sur ce plan					

주중한국문화원 1F 전시장
LAYOUT

2020. 12. 18.

MOVING PARTION

MODULE A



MODULE B



MOVING PARTION

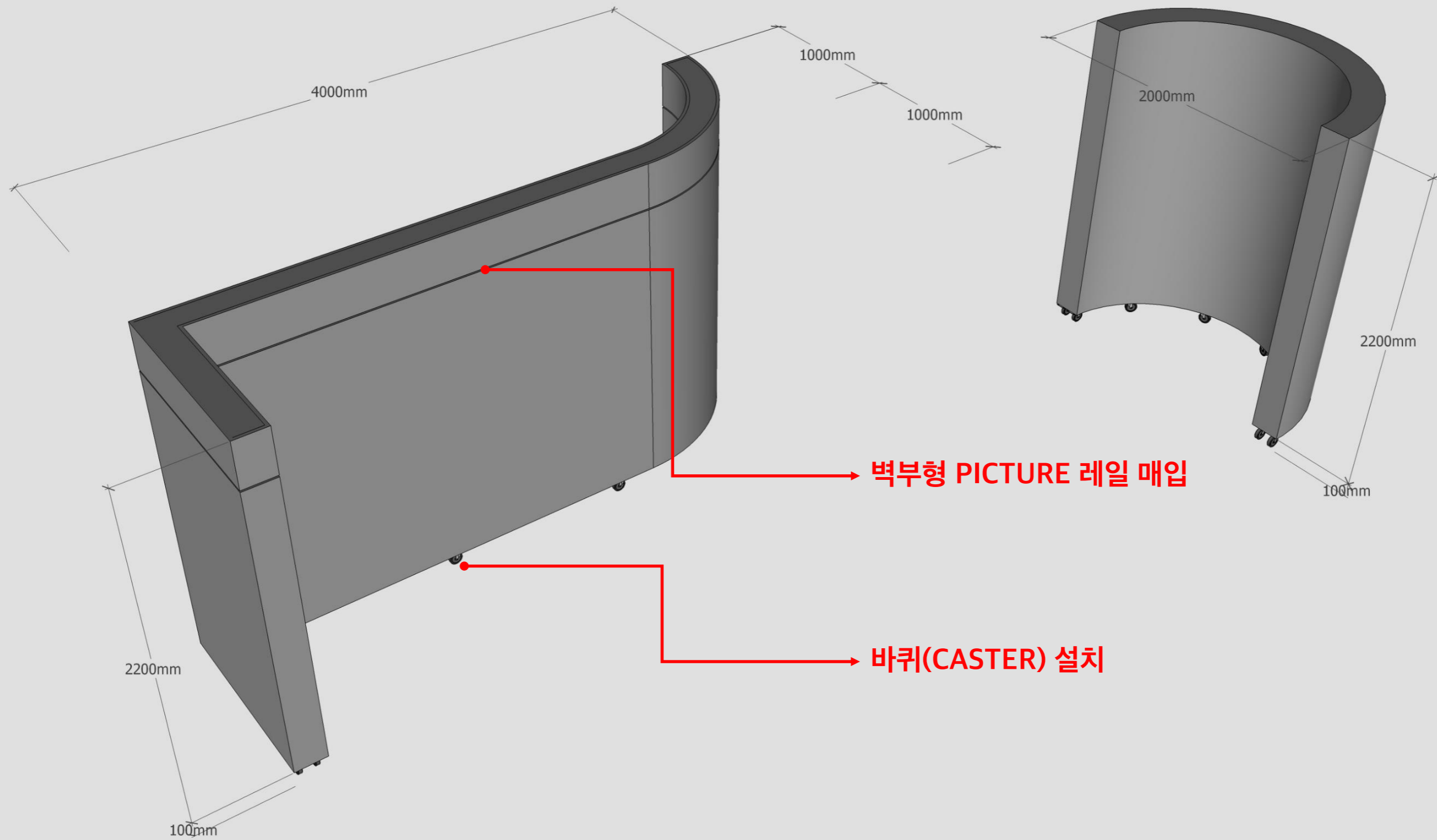

ALT 01 (예시 : 회화 + 조각)

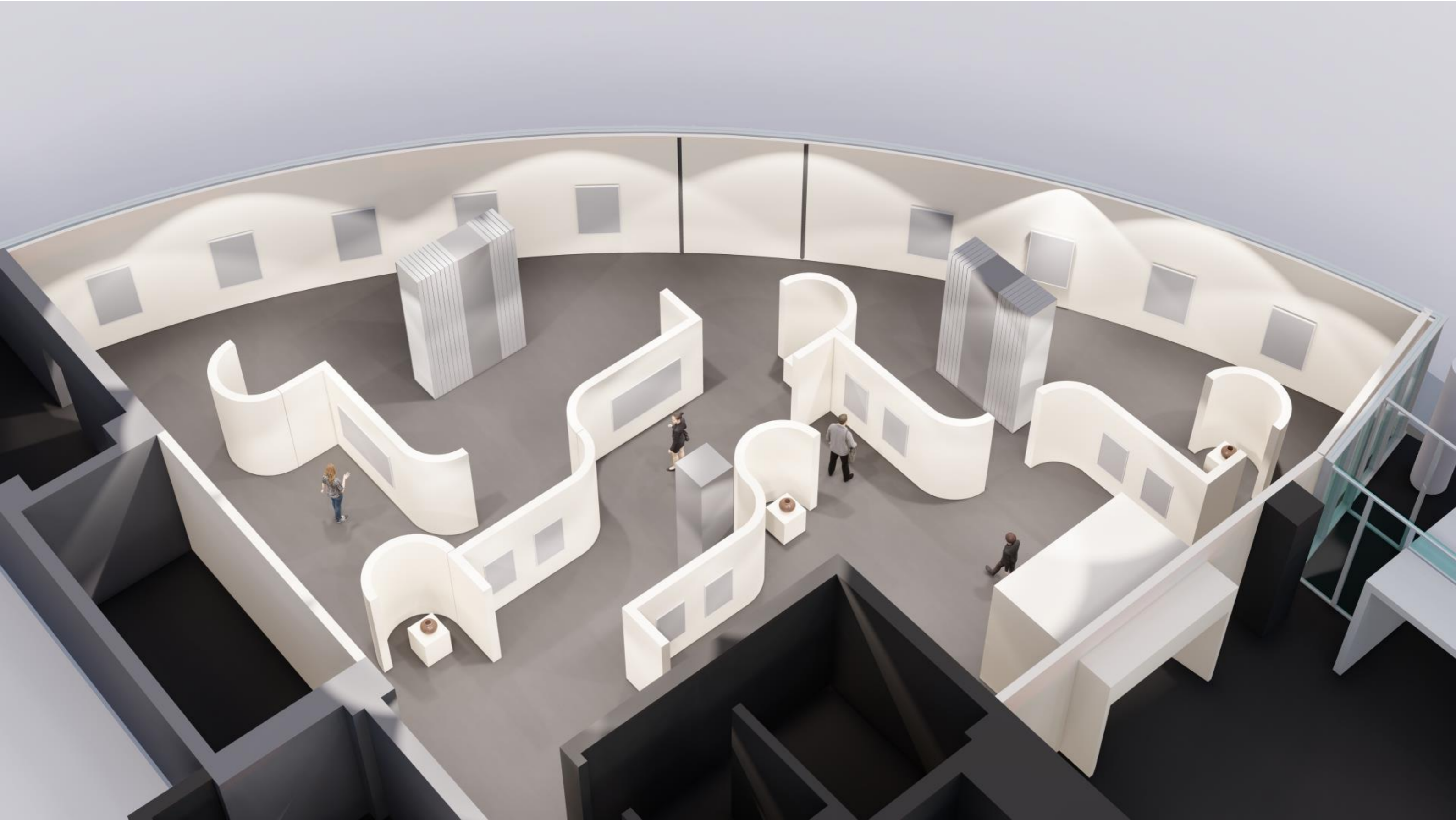

ALT 01 (예시 : 회화 + 조각)

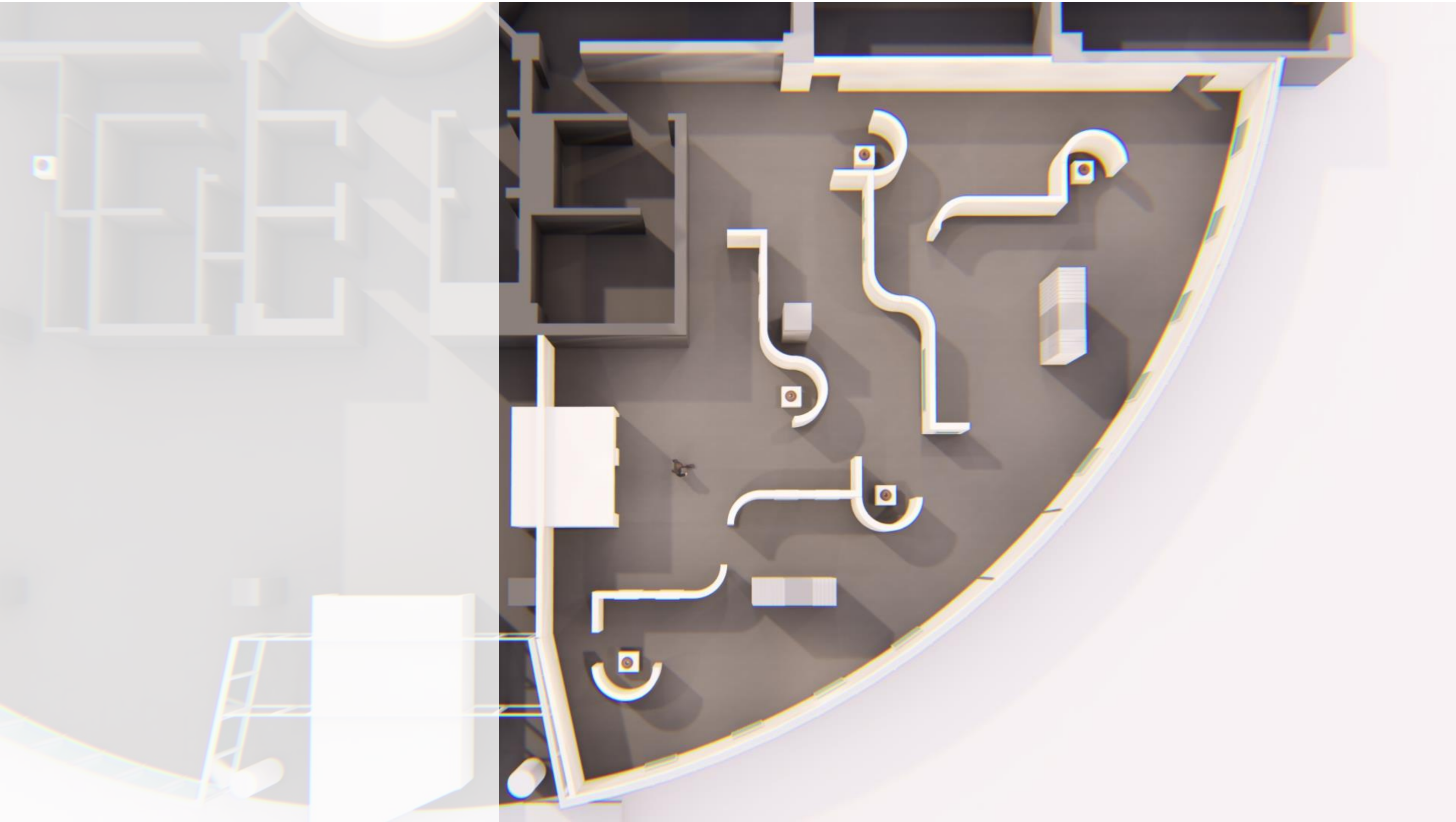

ALT 02 (예시 : 조각 위주)

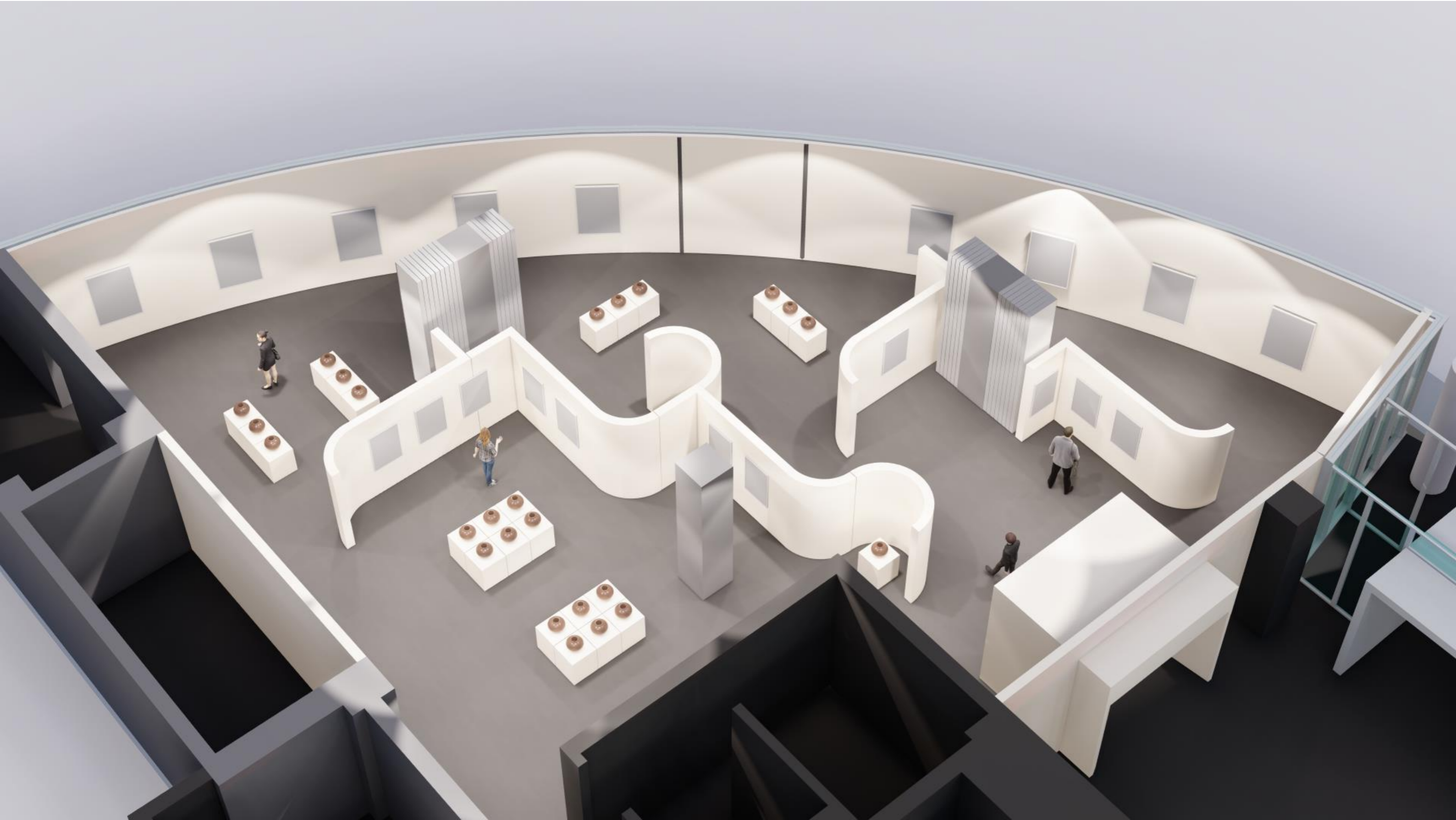

ALT 02 (예시 : 조각 위주)

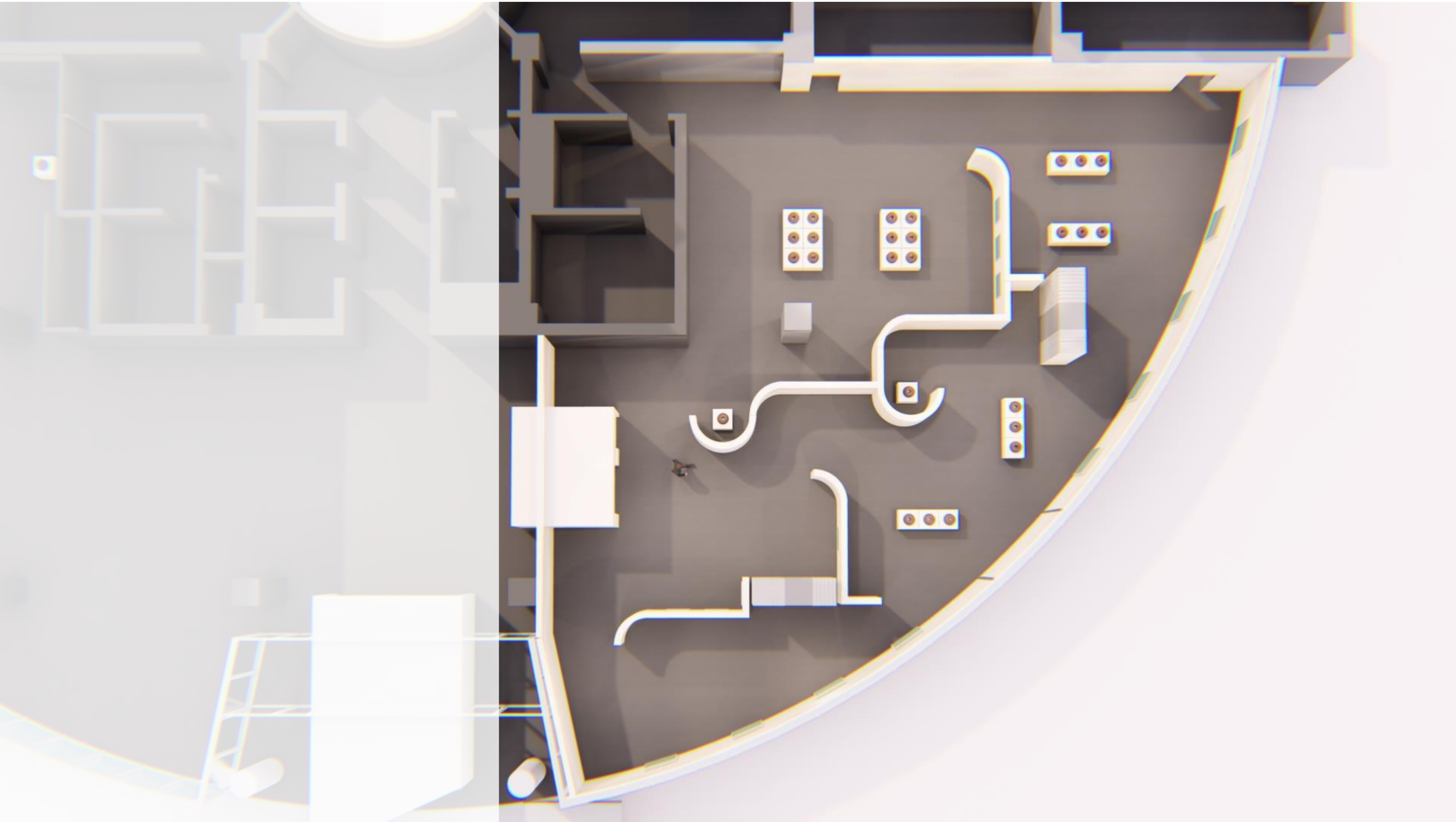

ALT 03 (예시 : 회화 위주)

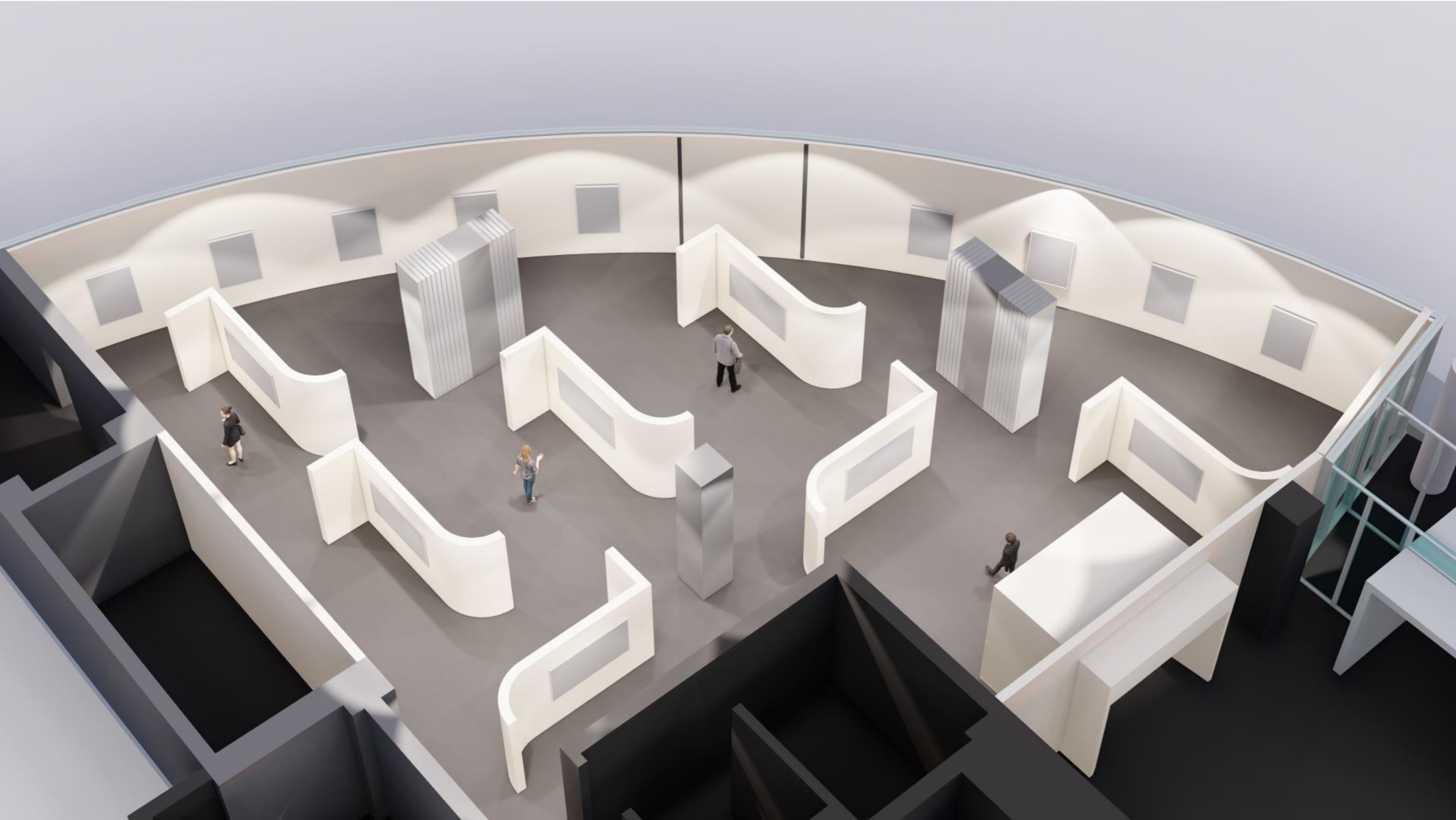

ALT 03 (예시 : 회화 위주)

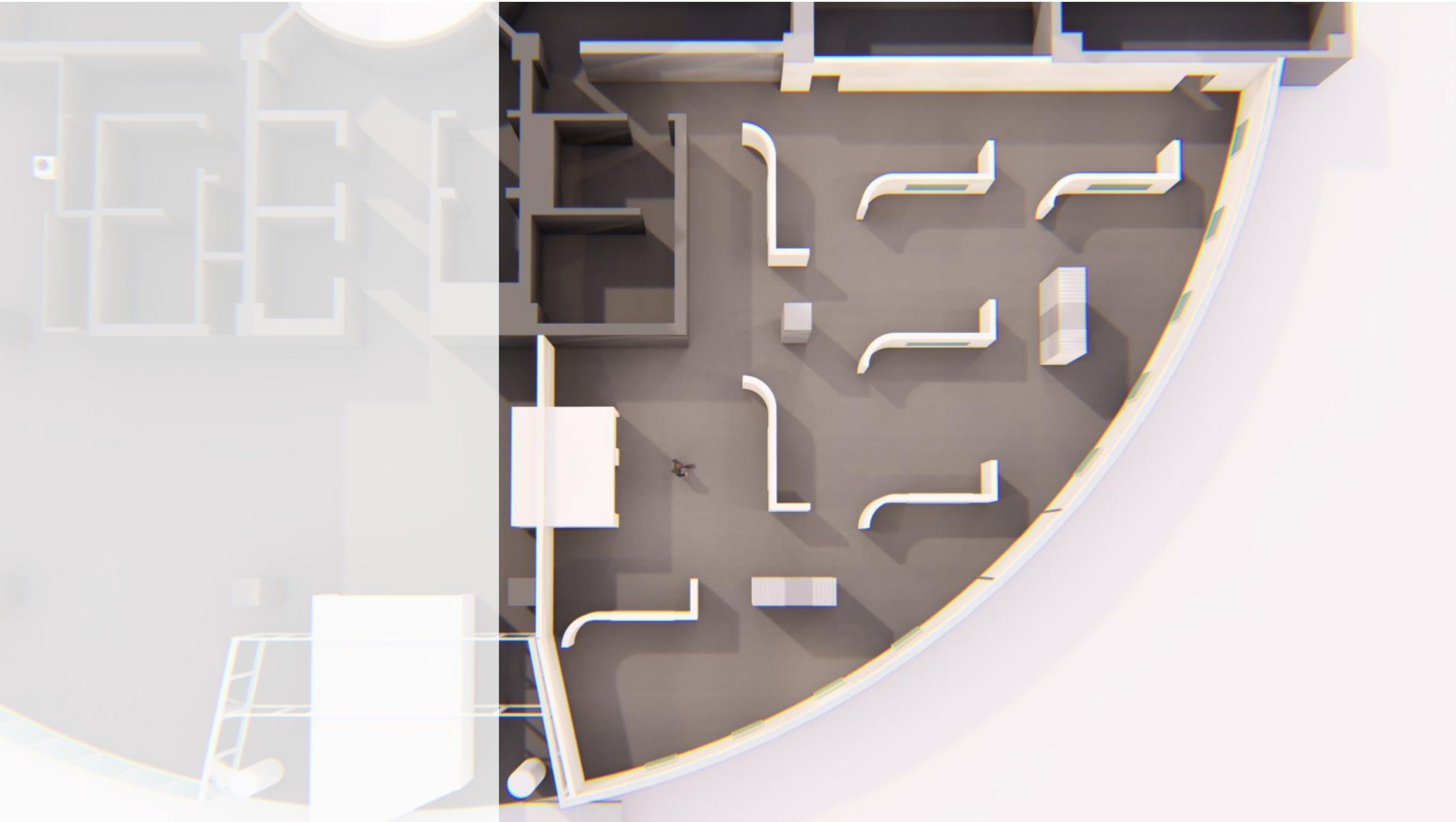

ALT 04 (전시장 미사용 시)

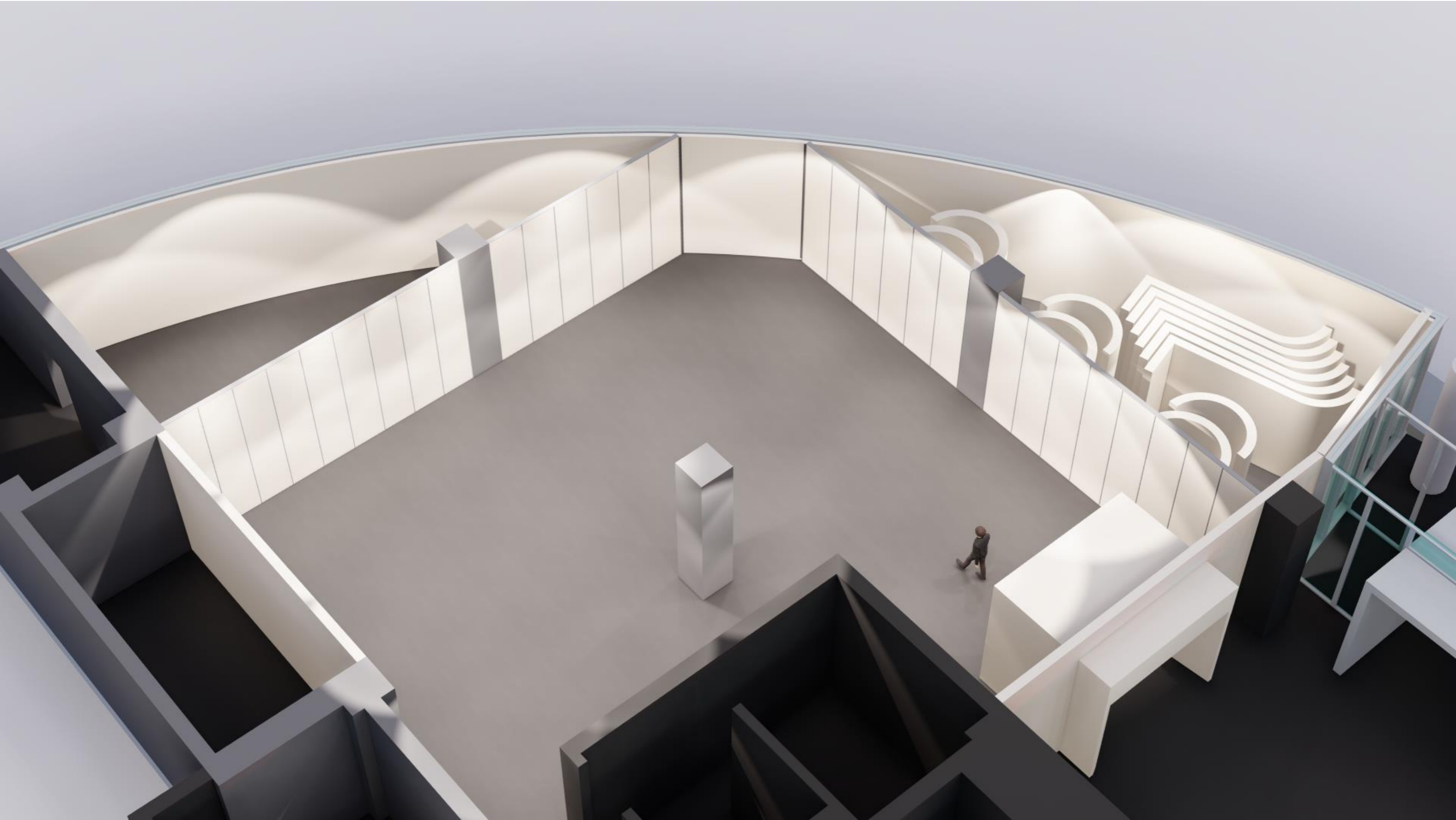

ALT 04 (전시장 미사용 시)

